

EFE - KMT GALVANO



www.efe-kmt.com.tr

e-mail: info@efe-kmt.com.tr

g-mail: efe.kmt@gmail.com

Tel: +90 224 477 00 57

Mob: +90 553 307 01 64

ELECTROPLATING AND INDUSTRIAL PLANTS

- Plastic products manufacturing
PP, PE, PVC, PVDF
Tanks and special manufacturing
Installation and Assembly Works
Waste Air (Scrubber)
Wastewater treatment Plants
- Steel and stainless steel manufacturing
- Projecting, Manufacturing, Assembly, Revision, Service



OUR SCOPE

- **ELECTROLYSIS COATING PLANTS •**

- AUTOMATIC, SEMI-AUTOMATIC, MANUAL
- AUTOMOTIVE INDUSTRY
- DEFENSE INDUSTRY
- ELECTRONICS INDUSTRY
- MEDICAL INDUSTRY

- **VENTILATION SYSTEM**

- ASPIRATOR
- GAS WASHER (SCRUBBER)

- **WASTEWATER TREATMENT PLANTS**

E-COATING PLANTS

MAROCCO

BASKET, 6 HOIST

1400X2300X1800, 1800 KG

PLC CONTROLLED

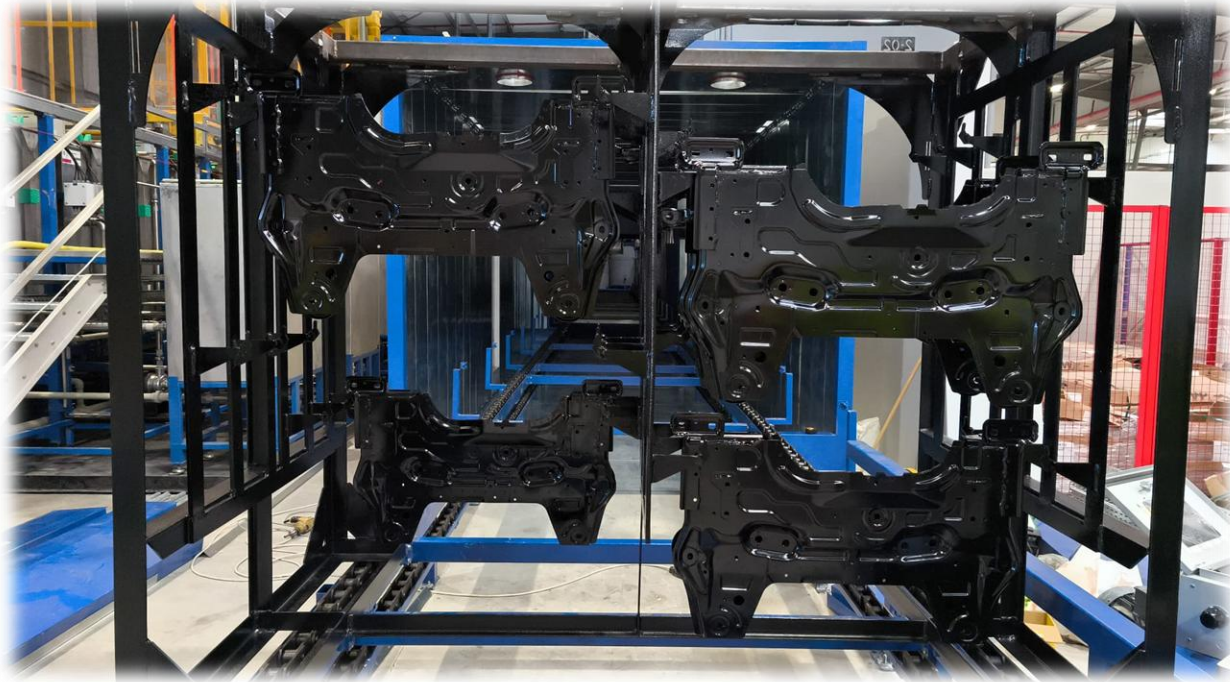

3.10.2025
Nilüfer, Bursa



EQUIPMENTS

DEGREASING & PASSIVATION LINE

GERMANY

BASKET, 2 HOIST, 1400X2300X1800, 1800 KG
PLC CONTROLLED





EQUIPMENTS



PHOSPHATING PLANTS

KAZACHSTAN

MANGAN PHOSPHATE
FRAME- BASKET – BARREL







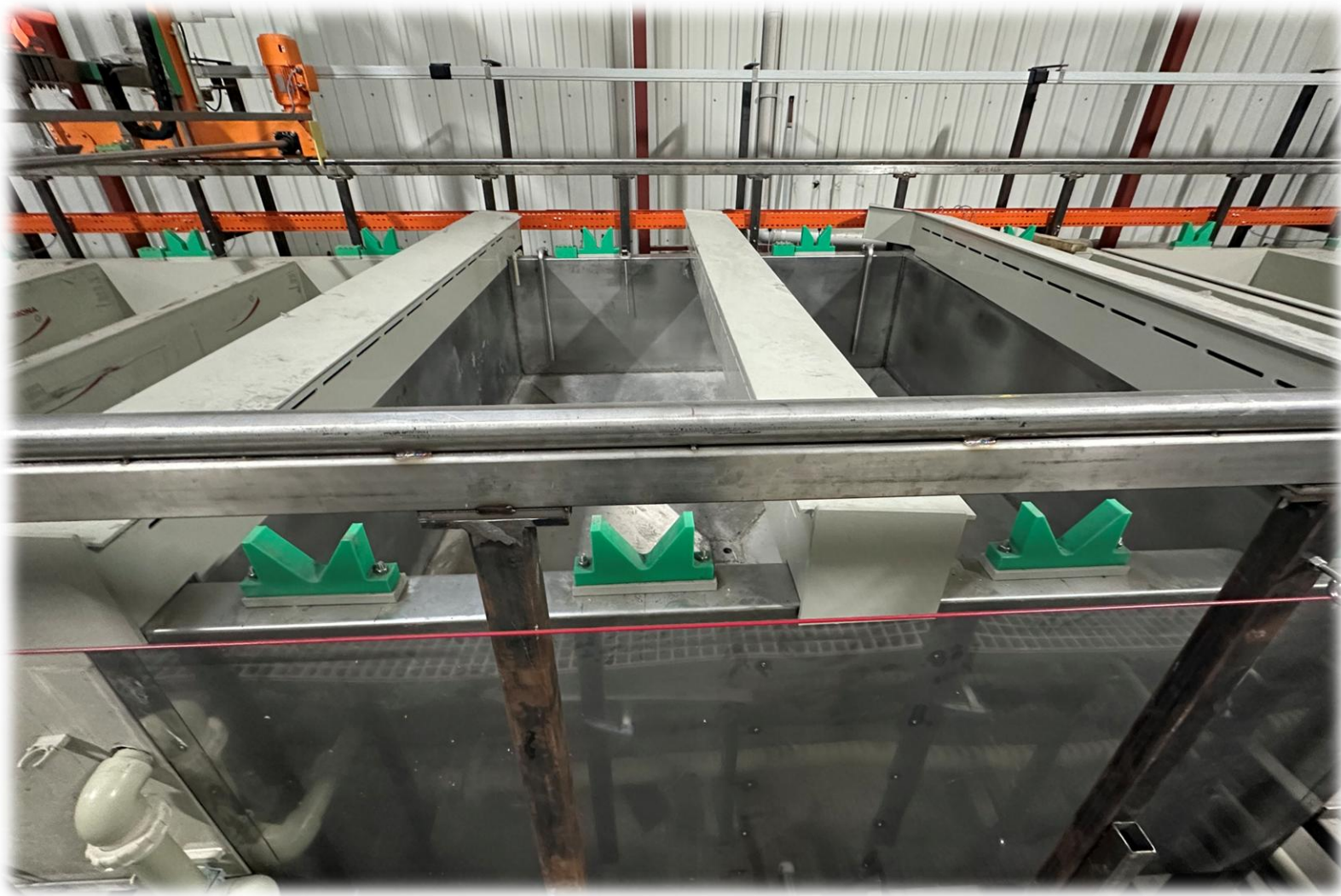



ALODYNE COATING



GERMANY
Aviation Sector
2 HOIST
PLC CONTROLLED



ANODISING PLANTS

GERMANY

Aviation Sector

2 HOIST

PLC CONTROLLED

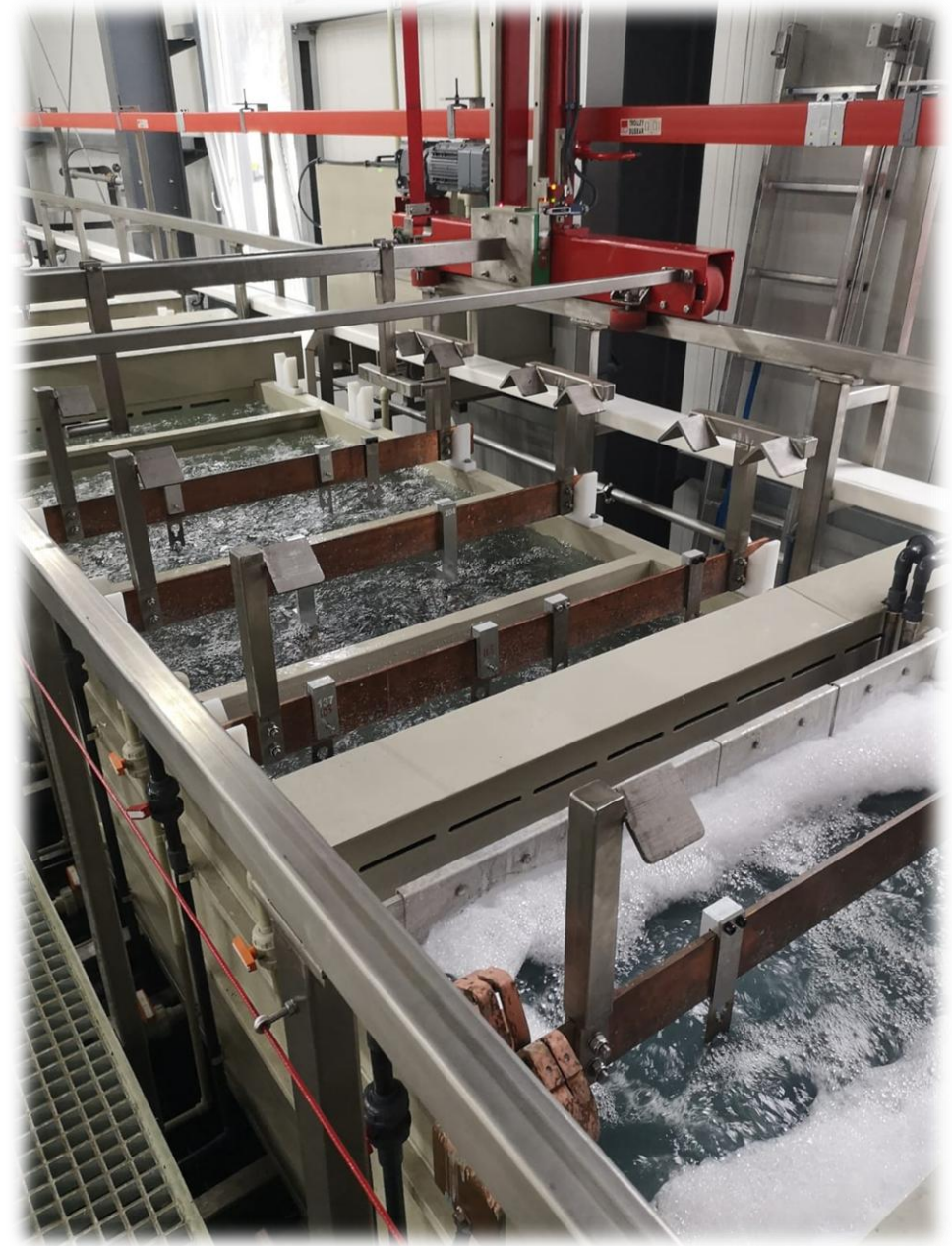



TIN BARREL PLANTS

GERMANY

Automotive Sector

Barrel 80kg, 1 Hoist, PLC Controlled



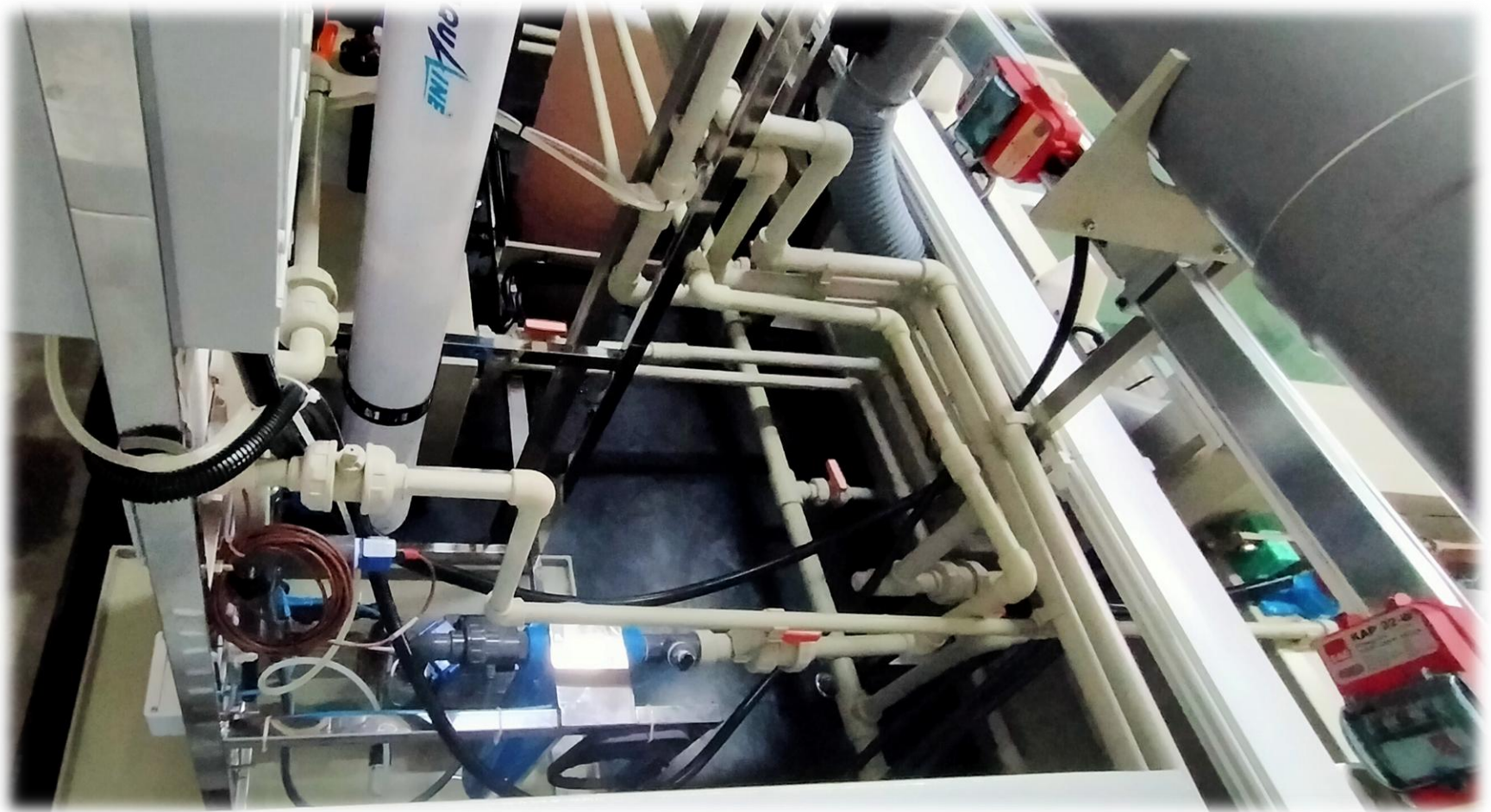

E-COATING PLANTS

- **HUNGARY**
- 1800 x 1200
- PLC CONTROLLED
- 2 HOIST







REEL TO REEL PLATING LINE

TÜRKIYE
Electronics Sector
Cu - Ni - Zn - Ag - Au



PLANNING MANUFACTURING ASSEMBLY SERVICE

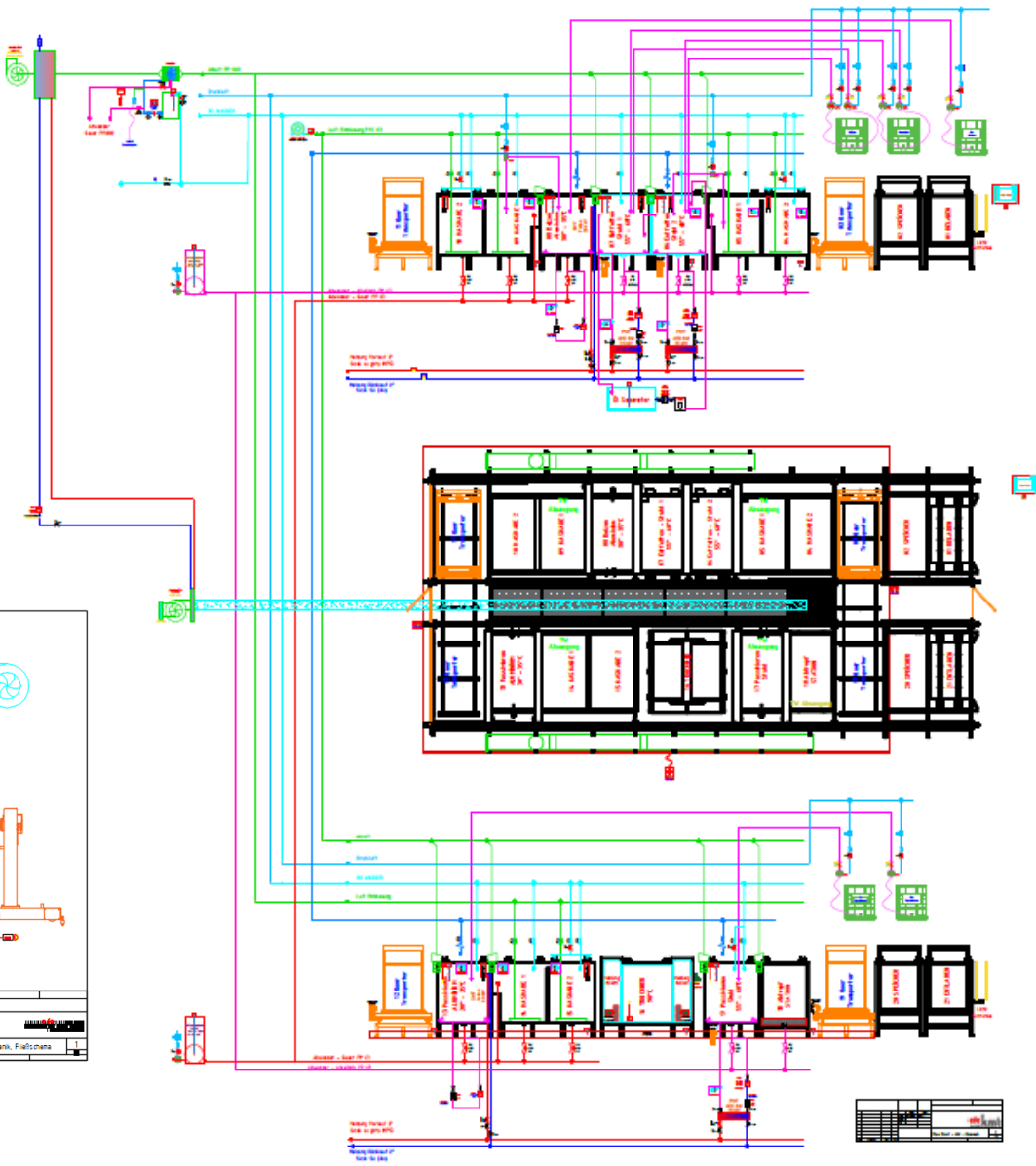
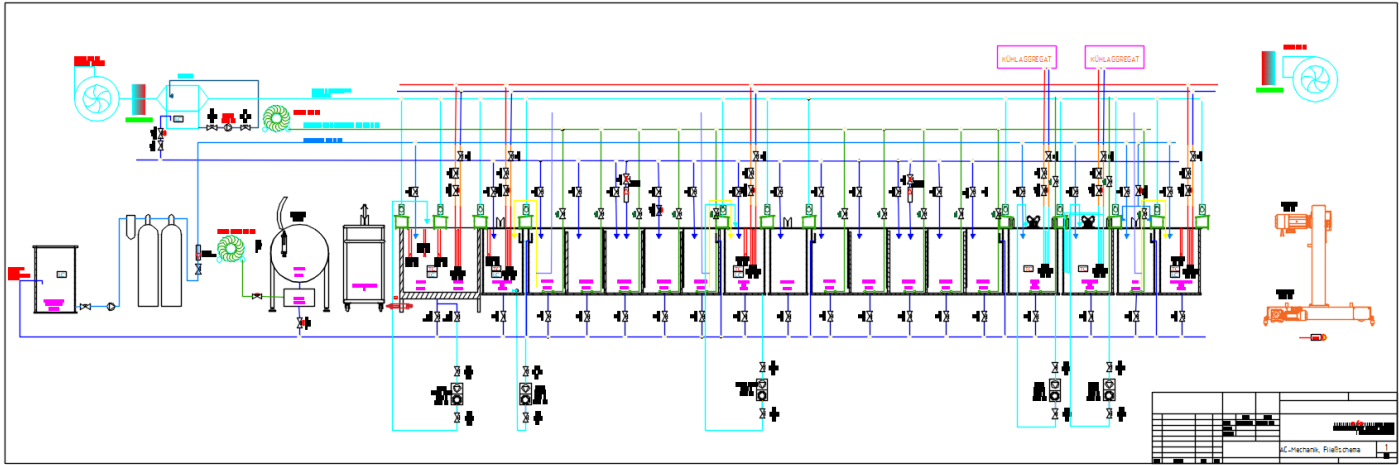

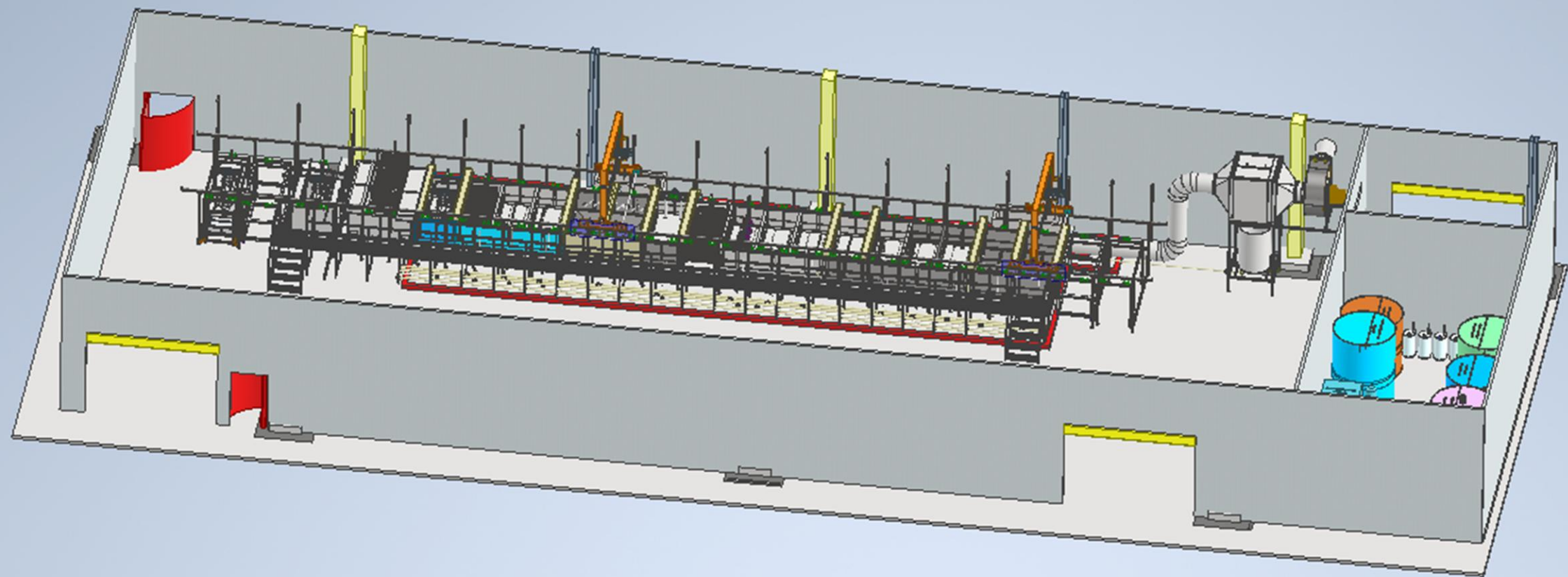

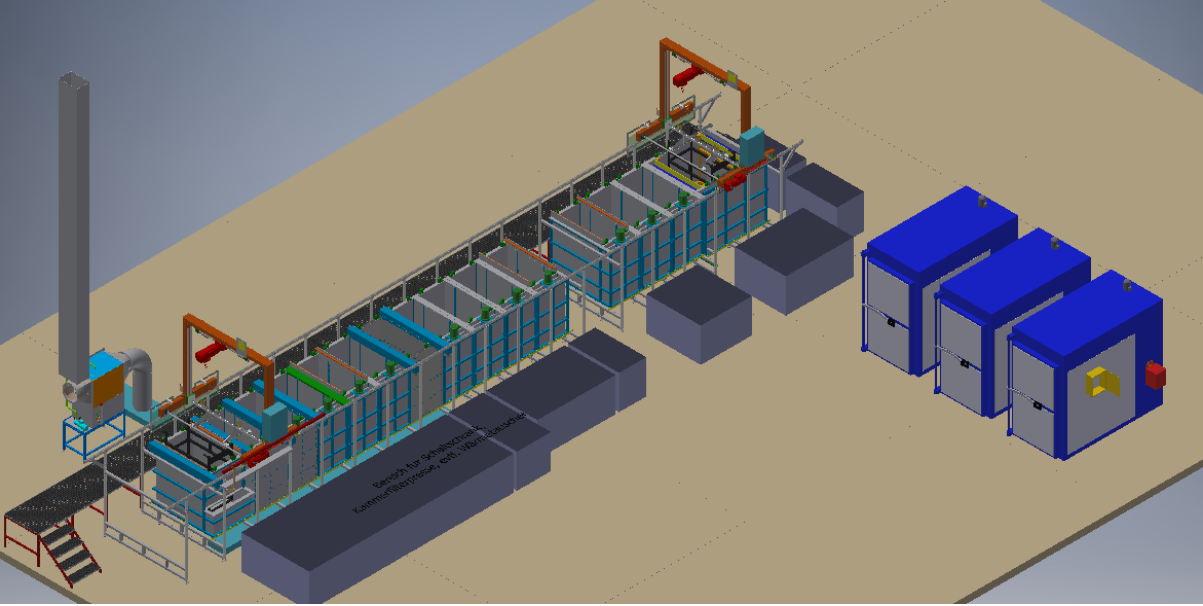
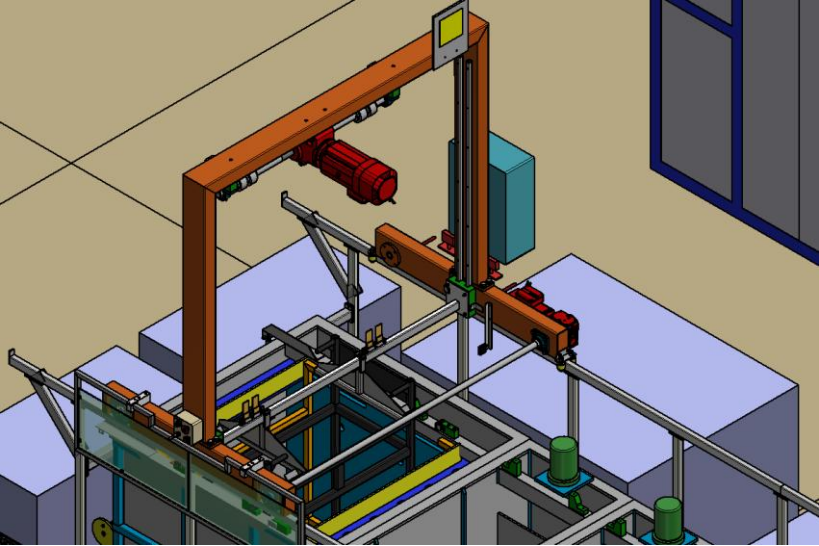
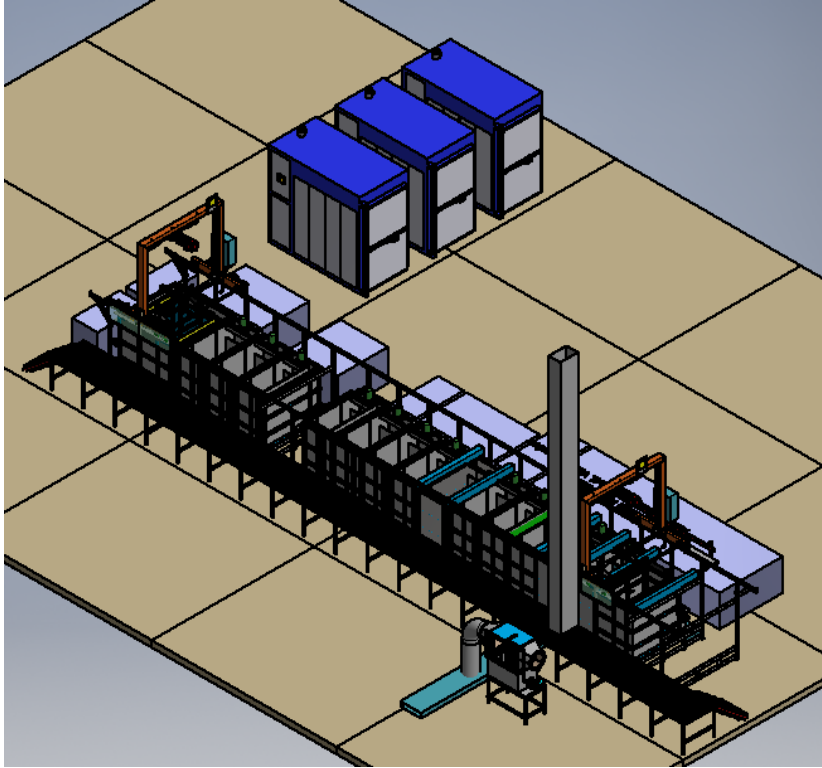

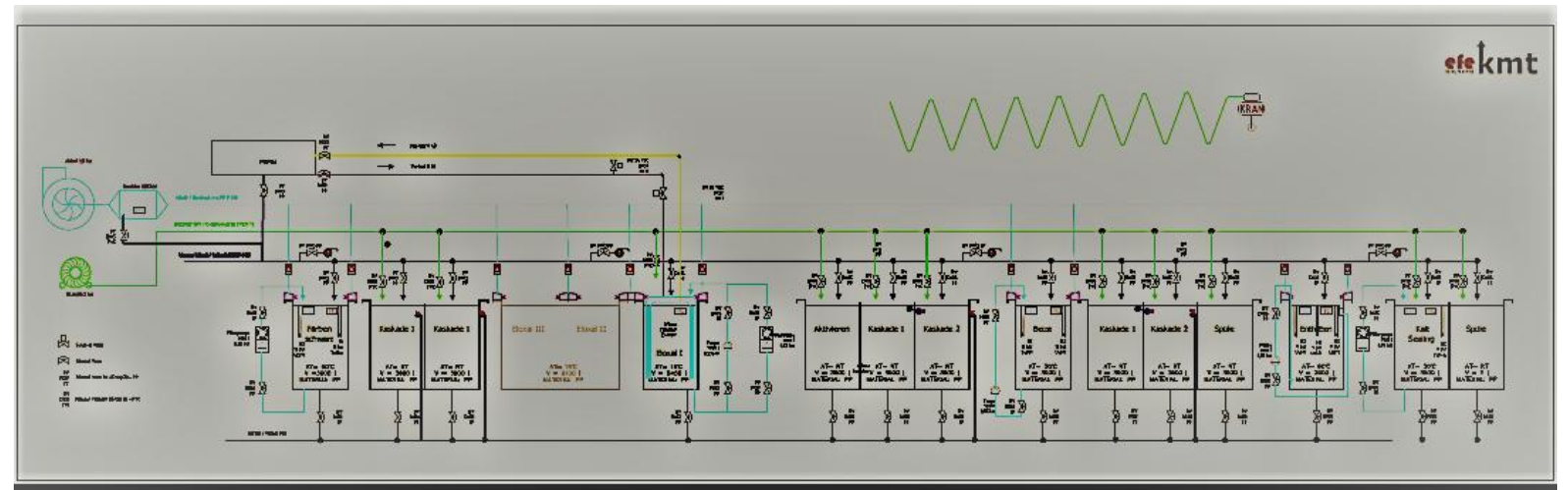
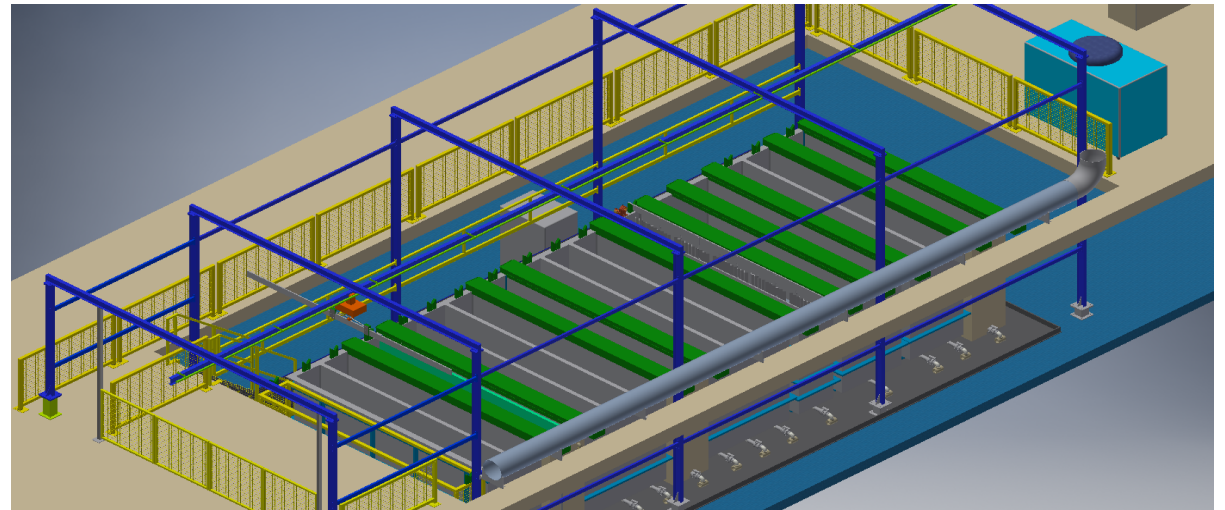

REEL TO REEL PLATING LINE, TÜRKİYE

- Cu – Zn – Ni - Ag



ANODIZING PLANTS



- **GERMANY**
- 4000 x2000
- Manual

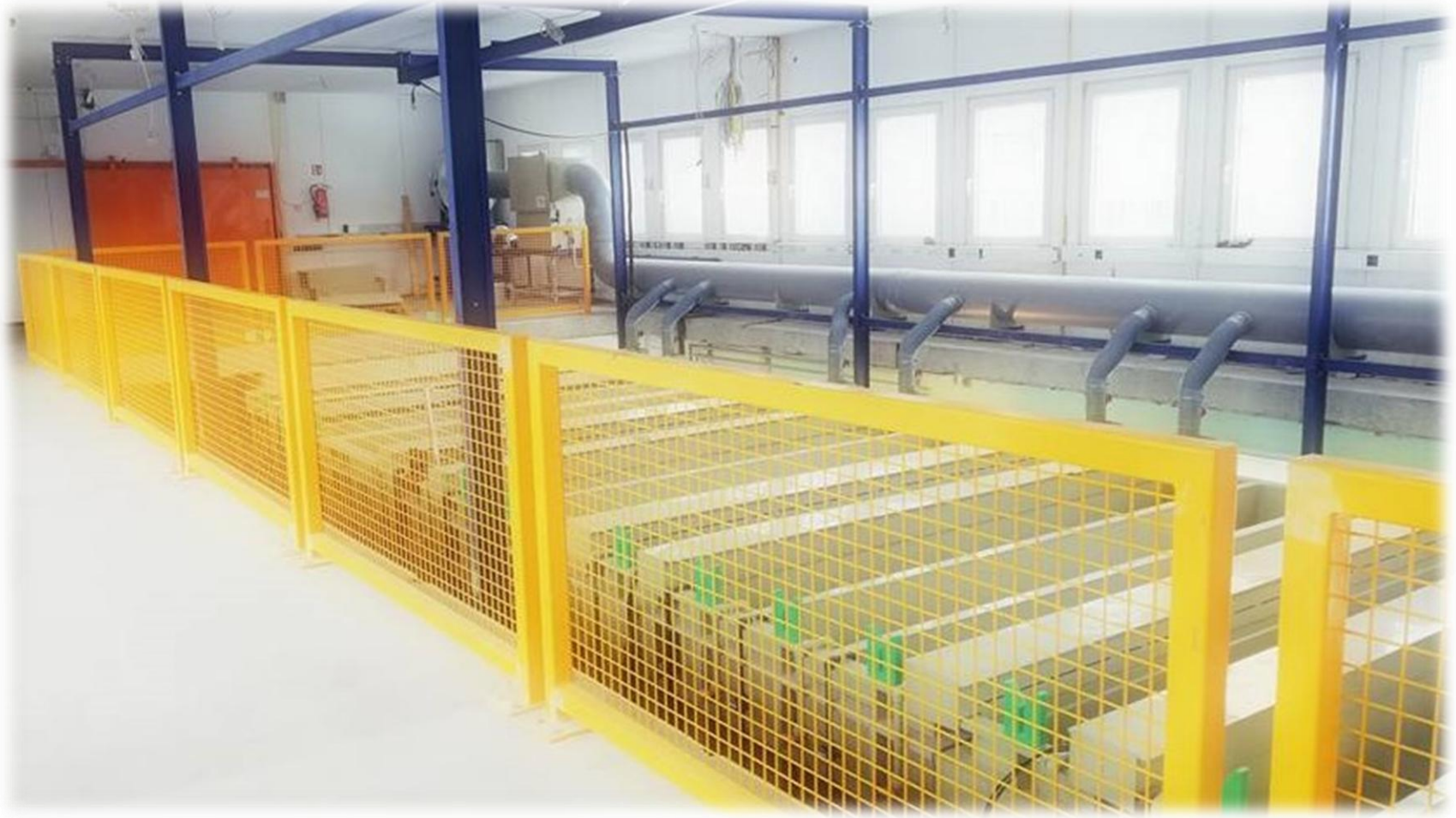



ZİNC - ACİD

- **TÜRKİYE**
- 3000 x 1800
- PLC CONTROLLED
- 4 Hoist



EXHAUST AIR SCRUBBER PP / PVC / PE / TI

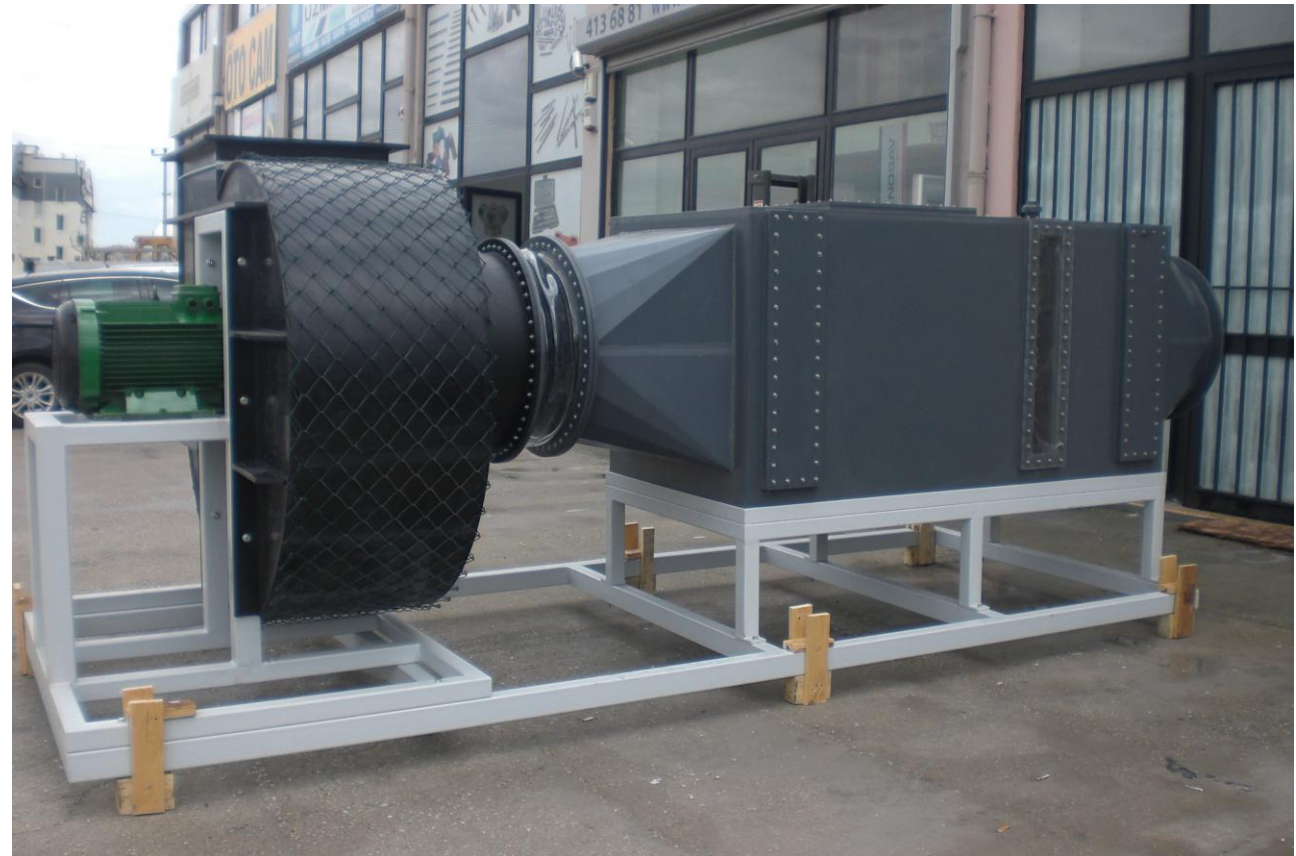



EQUIPMENTS

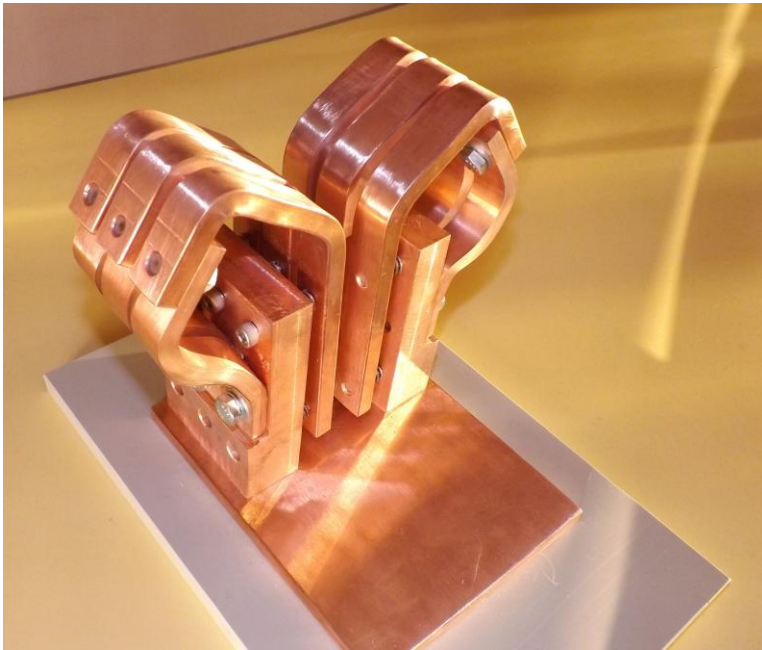



SPECIAL EQUIPMENTS



TANKS







Die TÜV SÜD Industrie Service GmbH
als anerkannte Sachverständigenorganisation nach § 22 VAwS
bescheinigt, dass

Yilmaz Efe
geboren am 01.12.1964 in Türkei

beschäftigt bei

Efe Kmt Galvano
Izmir yolu cad. 641/5
16240 Bursa - Türkei

an der Veranstaltung

**WHG-Grundkurs für betrieblich verantwortliche Personen in
Fachbetrieben nach WHG (ehemals § 191 WHG)
Voraussetzung für die fachspezifischen WHG-Kurse**

der TÜV SÜD Akademie GmbH
am 17.07.2017 in Augsburg
teilgenommen und die dabei erworbenen Kenntnisse durch eine
Prüfung gemäß VdTÜV-Prüfungsordnung mit Erfolg nachgewiesen
hat.

Augsburg, den 17.07.2017

Prüfungskommission

Dipl.-Ing. Norbert Hartmann
Sachverständiger
TÜV SÜD Industrie Service GmbH

Dipl.-Ing. Wilhelm Mengele
Abteilungsleiter
TÜV SÜD Industrie Service GmbH



REFERENCE

BENTELER 

 **BOSCH**

reisinger

**BVS Lippert**

Beratung • Vertrieb • Service



WILKENS
Silbermanufaktur seit 1810

 **DEWE**
BRÜNOFIX
Fabrik für Metallchemie

KAMLIT 
KAZACHSTAN

ALOXANAL
OBERFLÄCHENTECHNIK

leist

 **Schneider**
KREUZNACH

 
Stich Industrie-Lackierung GmbH

 **ROGAL**
METALLVEREDELUNG

www.eloxal24.com

The logo for NORM CIVATA features a blue circular icon with a white stylized bolt or screw on the left. To its right, the word "NORM" is written in a large, bold, blue sans-serif font. Below "NORM", the word "CIVATA" is written in a smaller, blue, spaced-out sans-serif font.

The logo for BARIŞ consists of the word "BARIŞ" in a black, bold, sans-serif font. A stylized graphic element, resembling a red dot with a black orbital path, is positioned over the letter "I".

a.plas

Plastik ve Lastik sanayii

The logo for HATKO ELECTRONICS features a blue square icon containing the letters "HE" in white. To the right of the icon, the word "HATKO" is written in a blue, bold, sans-serif font, and "ELECTRONICS" is written below it in a smaller, blue, bold, sans-serif font. A registered trademark symbol (®) is located to the right of "ELECTRONICS".

CeS
cnc engineering solutions

The logo for RIMMLER METALLVEREDELUNG features a stylized graphic of four vertical bars of increasing height on the left. To the right, the word "RIMMLER" is written in a large, blue, bold, sans-serif font. Below it, "METALLVEREDELUNG" is written in a smaller, blue, bold, sans-serif font. On the far right, "GmbH & Co. KG" is written vertically in a small, blue, sans-serif font.

galvanowerk holbe

The logo for SFS intec features the word "SFS" in a large, bold, orange sans-serif font. Below "SFS", the word "intec" is written in a smaller, grey, sans-serif font. The entire logo is framed by a thick black horizontal bar above and below.

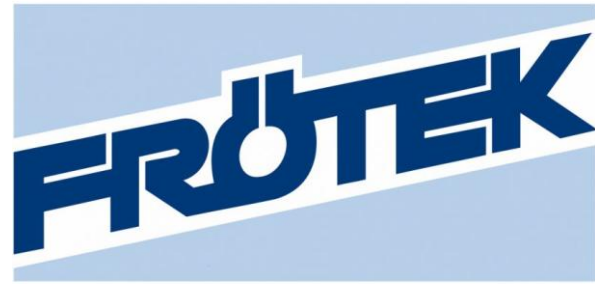





SCHAEFFLER





THANK YOU

- www.efe-kmt.com.tr
- info@efe-kmt.com.tr
- +90 224 477 00 57
- +90 553 307 01 64